

**Omni-Directional Presentation
Laser Scanner**
NOVA N-4070



User's Manual

Copyright © 2012.

This manual is copyrighted, with all rights reserved. Under the copyright laws, this manual may not, in whole or in part, be copied, photocopied, reproduced, translated or converted to any electronic medium or machine readable form without prior written consent of the manufacturer.

Important

This equipment has been tested and found to comply with the limits for a Class B digital device, pursuant to EN55022, and with the limits for a class A digital device, pursuant to part 15 of the FCC rules. These limits are designed to provide reasonable protection against harmful interference when the equipment is operated in a commercial environment. This equipment generates, uses, and can radiate radio frequency energy and, if not installed and used in accordance with the user's manual, may cause harmful interference to radio communications. Operation of the equipment in a residential area is likely to cause harmful interference in which case the user will be required to correct the interference at his own expense. Any unauthorized changes or modifications to this equipment could void the user's authority to operate this equipment.

For CE-countries:

- This equipment is in conformity with the CE standards.

Table of Contents

Table of Contents	iii
Preface.....	i
Chapter 1 Product Overview	3
1.1 Unpacking	4
1.2 Declaration of conformity	6
1.3 Scanning barcodes	8
1.4 Scanner labelling.....	9
Chapter 2 Installation	10
2.1 Connecting the scanner	11
2.2 Interface selection	13
2.3 Installing the scanner on a counter surface	14
Appendices	17
A Connector types and pin definitions	18
B Technical specifications	20
C Interface Type	22
D Maintaining the scanner	23
E Controlling the scanner from the POS	24
F Troubleshooting	25

Preface

This N-4070 is the continuation of the excellent optical design experience and with a new back-end design, to create an outstanding product performance and reliability. This scanner features high inerrability, flexibility, scanning, and decoding capability. It is ideally suited for supermarkets, pharmacies, petrol stations, and other similar retail stores.

Based on the standard product reliability, the product design concept is fully focused on user's context and mode. It also reduces time and cost.

Our solutions provide instant and accurate scanning, making the checkout process more efficient for you and more convenient for your customers.

- Reduce checkout lines at busy times, including weekends and holidays.
- Create additional points-of-sale anywhere in the store by enabling sales associates to access POS systems in real-time and complete transactions on the store floor.
- True presentation scanning, with Omni-directional and pass-by scan capabilities offer a faster and more natural way of working.

The N-4070 reads all popular barcode symbologies, and supports a wide range of scan pattern. In addition, this scanner also provides an aggressive first-pass scanning, reducing the time that takes to scan products, increasing customer satisfaction and employee efficiency. Another important feature of this scanner is its programmable sleep mode which is designed to save power on this scanner. If the scanner is not used within a programmable period of time, the scanner switches off automatically. The scanner can be re-activated by pressing the Sleep/Wake-up touch button on screen. The volume can easily programmed by Volume-Adjustment touch button on the screen as well. The N-4070 supports multiple interfaces for communication with any host system. The multiple interface versions are: RS-232, Keyboard Wedge, USB and Powered-USB (Option).

This manual contains two chapters and six appendices. The first chapter describes this scanner and its general features. The description for installation can be found in the second chapter. Precisely follow the instructions for the installation of the scanner. Default settings can be changed with the barcode labels from the Configuration Guide that came with the scanner. Appendix A gives the pin definition for the Data ports of the scanner. The pin definition may be required when you want to make a new cable for communication with the POS/computer. Technical

specifications of this scanner can be found in Appendix B. Refer to Appendix C for the interface cable types. For maintaining the scanner and controlling the scanner from the POS system, they can be found in Appendix D & E. Refer to Appendix F for troubleshooting if the scanner is not working properly.

Chapter 1 Product Overview

1.1 UNPACKING

Remove the scanner and its accessories from the box and packing material. Refer to the packing list to make sure you have received all the items ordered. Visually inspect the scanner and accessories for any evidence of physical damage. Refer to the figure on page 22 to locate the interface cable and make sure that the scanner interface corresponds with the host system interface. Immediately contact your supplier if anything appears to be damaged, or if the supported interface does not correspond with the host system interface.

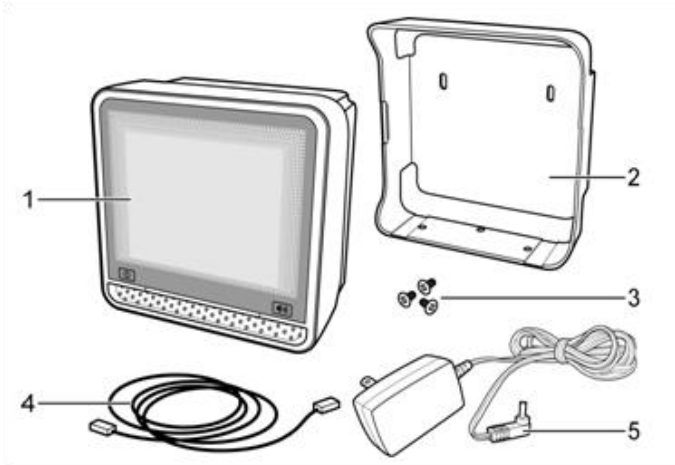

- | | |
|------------|--------------------|
| 1. Scanner | 4. Interface Cable |
| 2. Bracket | 5. Power Adapter |
| 3. Screws | |

The specific parts of this scanner are:

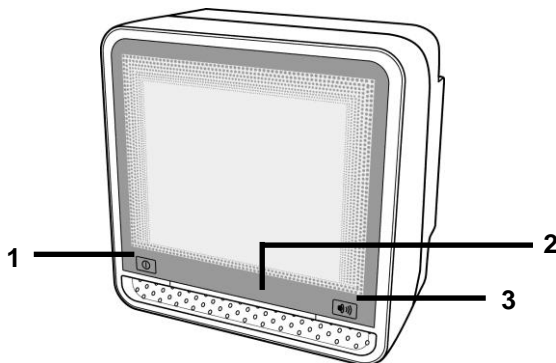

1. Sleep/Wake Button

- Press this button for 3 seconds, the scanner manually enters sleep mode.
- When a sleep mode time-out is programmed, the scanner can be activated by pressing this button. Moreover, the scanner may be automatically activated when any barcodes or objects pass-by the scanner.

NOTE: The default value for the sleep mode time-out is set to 10 minutes. When the scanner is in sleep mode, the LED is intermittently flashing blue.

2. LED

- A blue LED indicates that the scanner is ready to read a barcode. An orange LED indicates a good read.

3. Volume Button

- The beep is heard whenever data has been read correctly. The frequency and volume can be adjusted.

Standard parts & accessories:

Interface Cable

- One of various types of cable to connect the host computer / POS system.

Power Adapter

- Power the scanner via the AC power outlet if the scanner is not directly powered.

1.2 DECLARATION OF CONFORMITY

Will comply with the following product specifications:

Laser Safety: - IEC 825-1

Electrical Safety: - EN 60950

EMC: - EN 55022:2006 + A1:2007

- EN 61000-3-2: 2006

- EN 61000-3-3: 1995 + A1:2001 + A2:2005

- EN 55024:1998 + A1:2001 + A2:2003

- IEC 61000-4-2: 1995 + A1: 1998 + A2: 2000;

- IEC 61000-4-3: 2006 + IEC: 61000 -4-4: 2004;

- IEC 61000-4-5: 2005 + IEC: 61000 -4-6: 2003; +A1: 2004 +A2: 2006;

- IEC 61000-4-8: 1993 + A1: 2000; IEC 61000 -4-11:2004

LVD: - EN 60950-1:2006+A11 1:2009

Laser Safety

German:

Der Strichcode-Scanner entspricht den Sicherheitsvorschriften nach IEC 825-1 (1993) für ein Laserprodukt der Klasse I. Er entspricht auch U.S. 21CFR1040, anwendbar auf ein Laserprodukt der Klasse IIa. Vermeiden Sie langzeitiges Hineinblicken in direktes Laserlicht.

Dutch:

De scanner voldoet aan de veiligheidsnormen IEC 825-1 (1993) voor een Klasse I laserproduct. Tevens voldoet de scanner aan U.S. 21CFR1040, van toepassing op een Klasse IIa laserproduct. Vermijd langdurig kijken in direct laserlicht.

French:

Le scanner est conforme aux normes de sécurité IEC 825-1 (1993) s'appliquant à un produit laser de la classe I. Il est également conforme à la U.S. 21CFR1040 telle qu'elle s'applique à un produit laser de la classe IIa. Eviter de rester exposé longtemps à la lumière directe du laser.

Danish:

Skanneren er i overensstemmelse med sikkerhedsstandarden IEC 825-1 (1993) for laserprodukter i klasse I. Den er også i overensstemmelse med U.S. 21CFR1040, der gælder for laserprodukter i klasse IIa. Undgå at se direkte på laserlys i længere perioder.

Finnish:

Skanneri täyttää luokan I lasertuotteelle IEC 825-1:ssä (1993) asetetut turvavaatimukset. Se täyttää myös U.S. 21CFR1040:ssa asetetut vaatimukset siltä osin kuin ne koskevat luokan IIa lasertuotetta. Vältä pitkäaikaista suoraan laservaloon katsomista.

Swedish:

Avsökaren uppfyller säkerhetsnormen IEC 825-1 (1993) för laserprodukter av klass 1. Den uppfyller dessutom U.S. 21CFR1040 som gäller för laserprodukter av klass IIa. Undvik att titta i direkt laserljus under längre perioder.

Norwegian:

Skanneren er i samsvar med sikkerhetsstandarden IEC 825-1 (1993) for laserprodukter i klasse I. Den er også i samsvar med U.S. 21CFR1040 for laserprodukter i klasse IIa. Unngå å se langvarig på direkte laserlys.

Italian:

Lo scanner è conforme alle norme di sicurezza IEC 825-1 (1993) relative ad un prodotto laser di Classe 1. È inoltre conforme alla norma U.S. 21CFR1040 relativa ad un prodotto laser di Classe IIa. Evitare l'esposizione prolungata all'emissione diretta di luce laser.

Portuguese:

O scanner está conforme as normas de segurança IEC 825-1 (1993) para a Classe 1 dos produtos laser. Também está conforme a norma U.S. 21CFR1040 aplicada nos produtos laser da Classe IIa. Evite expor os olhos directa e prolongadamente aos raios laser.

Spanish:

El scanner reúne las normas de seguridad IEC 825-1 (1993) para un producto laser de Clase 1. Y también reúne las normas U.S. 21CFR1040 que se aplican a un producto laser de Clase IIa. Se debe evitar mirar muy fijo en luz láserica directa.

English:

The scanner complies with safety standard IEC 825-1 (1993) for a Class I laser product. It also complies with U.S. 21CFR1040 as applicable to a Class IIa laser product. Avoid long term viewing of direct laser light.

Optical:

The use of optical instruments with this product will increase eye hazard. Optical instruments include binoculars, microscopes and magnifying glasses but do not include eye glasses worn by the user.

Radiant Energy:

The scanner uses a low-power laser diode operating at 630...670 nm in an opto-mechanical scanner resulting in less than 0.6 mW peak output power. Laser light observed at 13 cm (5.1 in.) above the window through a 7 mm (0.28 in.) aperture and averaged over 1000 seconds is less than 3.9 μ W per CDRH Class IIa specification. Do not attempt to remove the protective housing of the scanner, as unscanned laser light with a peak output up to 0.8 mW could be accessible inside.

Laser Light Viewer:

The scanner window is the only aperture through which laser light may be observed on this product.

A failure of the scanner motor, while the laser diode continues to emit a laser beam, may cause emission levels to exceed those for safe operation. The scanner has safeguards to prevent this occurrence. If, however, a stationary laser beam is emitted, the failing scanner should be disconnected from its power source immediately.

Adjustments:

Do not attempt any adjustments to or alteration of this product. Do not remove the scanner's protective housing. There are no user-serviceable parts inside.

CAUTION: Use of controls or adjustments or performance of procedures other than those specified herein may result in hazardous laser light exposure.

1.3 SCANNING BARCODES

This scanner is an omni-directional presentation scanner featuring a 5-directional scan field with a 30-line scan pattern. Barcode labels can easily be read by presenting them to the scanner.

The optimal reading zone lies between 2 and 25 cm from the scanner window. The scan depth varies depending on the size of the barcode.

Scanning a barcode label, do the following:

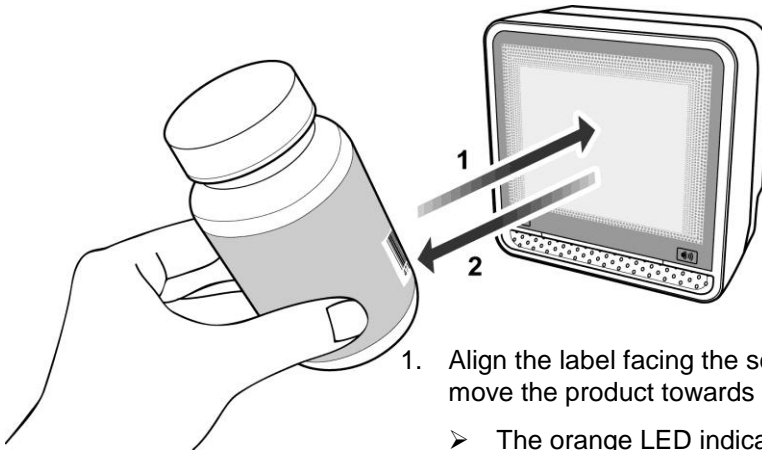

1. Align the label facing the scanner and move the product towards the scanner.
 - The orange LED indicates the barcode is read.
2. After the barcode is read, move the label from the scanner.

The scanner will automatically enter the sleep mode if the scanner is left idle for sleep mode time-out period (default is set to 10 minutes). During sleep mode, the scanner is automatically activated when it senses the presence of a barcode.

NOTE

With the Sleep mode feature, it helps user to conserve energy and extend the scanner life.

1.4 SCANNER LABELLING

Two labels are presented on the housing of this scanner as indicated in the figure below. Two labels are also visible through the scanner window. All labels are attached by the manufacturer and should not be removed.

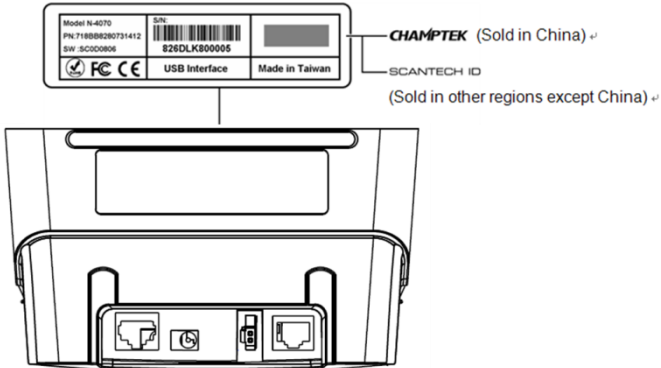

The scanner's serial number is found underneath the barcode label as depicted in the figure above. This official registration number is strictly related to the device. The supplier may ask for this number when the scanner needs servicing.

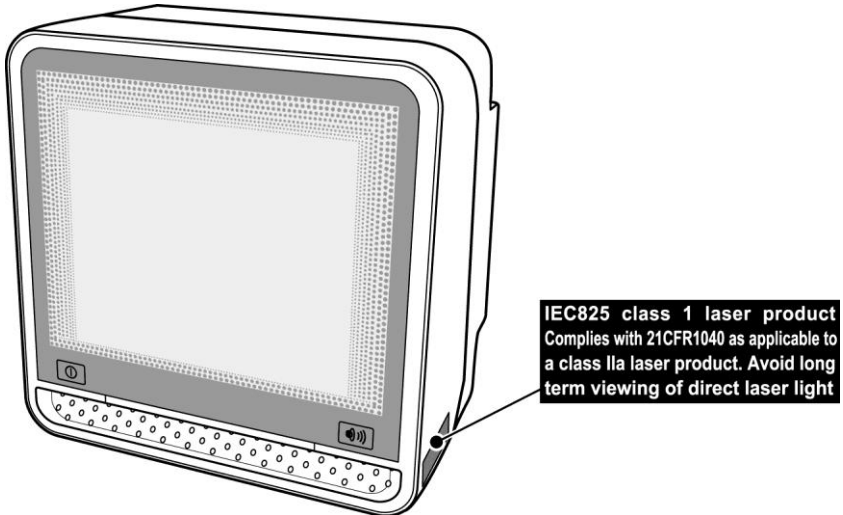

Chapter 2 Installation

This scanner can be installed on a counter surface. Instructions for installation on a counter surface are given in Section 2.3.

Due to many POS systems on the market, a variety of communication cables are available. Make sure that you have the right cable to connect the scanner to your POS or computer.

NOTE

The scanner and the host system must be switched off before starting the installation of the scanner. By following this precaution you prevent any electrical damage.

You are advised to install the scanner in an air circulated place out of direct sunlight.

2.1 CONNECTING THE SCANNER

To properly connect the scanner, do the following:

1. Plug the interface cable (in port 1) and ensure the scanner is properly connected to the host.
2. Connect the power adapter. The scanner will automatically activate and detect the setup interface.
3. Press the Volume Button (see page 5) repeatedly to adjust the frequency and volume level.

Use the illustration below to see where to connect your cable(s) to the scanner.

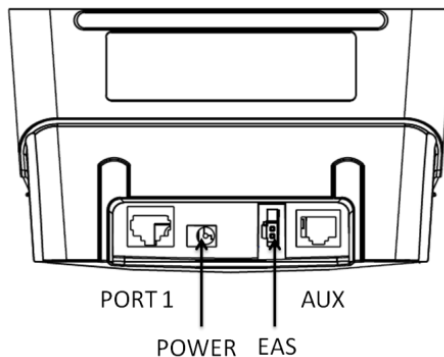

To change another interface cable:

1. Press and hold the Sleep/Wake Button (see page 5) until the scanner enters sleep mode.
2. Remove the power adapter.
3. Change the interface cable.
4. Connect the power adapter again to activate the scanner and detect the new connection.

NOTE

If you use "Direct Powering", the power is supplied by the host and you do not need to connect an external power supply to the Power Input entry.

2.2 INTERFACE SELECTION

This scanner allows you to connect your host system using four different interface cables : RS232, Keyboard Wedge, USB, and Powered USB(Optional). On powering up, the scanner senses the type of the interface used and switches to the appropriate protocol.

2.3 INSTALLING THE SCANNER ON A COUNTER SURFACE

To install this scanner on a counter surface, follow the instructions below.

1. Remove the bracket from the back of the scanner.

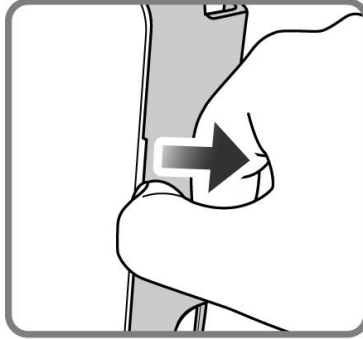

2. Place the bracket on a counter surface and fasten the bracket to the surface with three screws as illustrated in the figure.

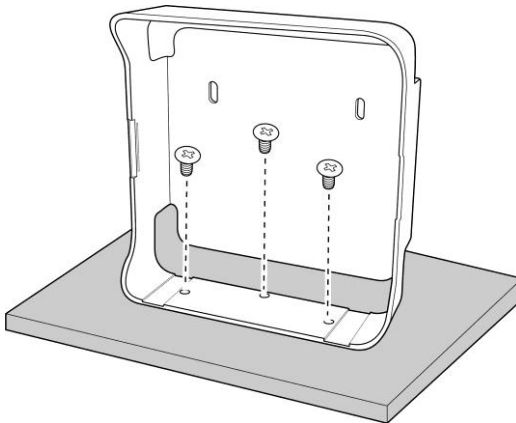

NOTE

- Use the bracket as a template to mark the places for the mounting holes at the counter surface and drill three holes.

3. Lead the communication cable and power supply cable through the slit.

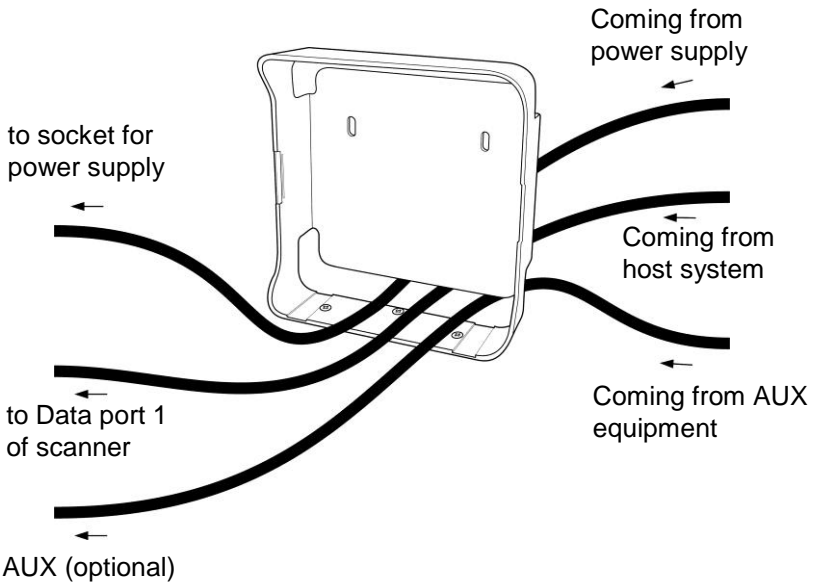

4. Make sure that connectors and cables are placed as indicated in the figure and attach the scanner to the bracket.

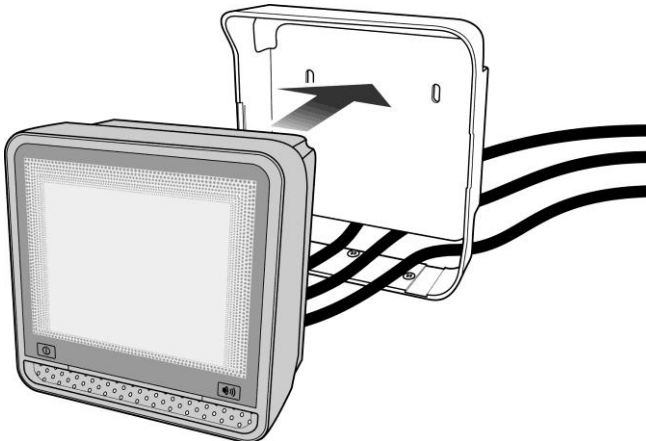

5. Plug the remote ends of all cables into the appropriate connections of your host POS-system.

6. If you are using an external power supply, power on this scanner by plugging the power supply into an AC power outlet. Switch on the host system.

IMPORTANT

To activate USB or KBW interface, scan the following codes from the Configuration Guide:

1. **Open** the scanner Programming Mode by scanning code1.1.
2. **Return to factory default settings** by scanning code1.3.

Once this scanner is installed, you can start scanning barcode labels. If you want to change the default settings of the scanner, proceed to the Configuration Guide which came with this scanner.

Wall mount installation

To install the bracket on the wall, do the following:

4. Locate an ideal position on the wall.
5. Use the bracket as a template to mark the places for the mounting holes and drill two holes.
6. Fasten the bracket to the surface with two screws as illustrated in the figure.

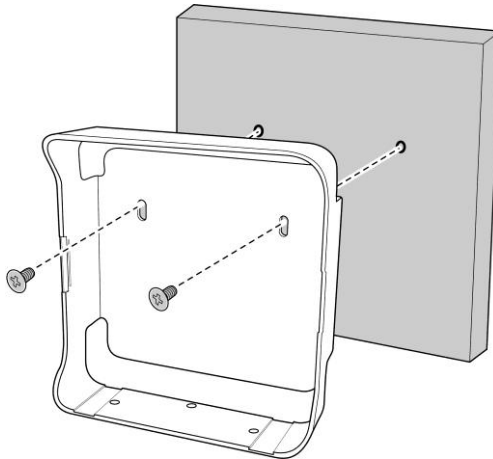

Appendices

- A. Connector Types and Pin Definitions**
- B. Technical Specifications**
- C. Interface Type**
- D. Maintaining the Scanner**
- E. Controlling the Scanner From the POS**
- F. Troubleshooting**

A CONNECTOR TYPES AND PIN DEFINITIONS

This scanner supports four interfaces in one standard unit, includes RS232, Keyboard Wedge, USB and Powered USB (option). The various pin definitions for the applicable data port are given on page 17 and 18. The connector to be used for the port is indicated below.

To activate USB or KBW interface, follow this sequence:

1. Plug in the appropriate interface cable and then power up the scanner.
2. Scan the following codes from the Configuration Guide:
 - **Open** the scanner Programming Mode by scanning code 1.1
 - **Return** to factory default settings by scanning code 1.3

Pin definitions for multiple interface: Connector: RJ-48, 10 pins

	Multiple Interface				
	RS-232	KBW	USB	Powered USB	
Pin	Description	Description	Description	Description	Remark
1	-	-	IFID	IFID	IFID = Interface ID
2	CTS	PC-Clock	-	-	-
3	RxD	PC-Data	-	-	-
4	TxD	KB-Data	-	-	IFID = Interface ID
5	RTS	KB-Clock	-	-	-
6	Ground	Ground	Ground	Ground	Ground
7	-	PC - 5V	PC - 5V	-	-
8	-	-	-	+12V	Direct Power, may be used to power scanner
9	-	IFID: connect to '6'	D +	D +	IFID = Interface ID D + = USB data
10	-	-	D -	D -	D - = USB data

Pin definition for all scanner versions:

AUX Port for HH scanner		
Pin	Description	Direction
1	+5 VDC	output
2	CTS	input
3	RXD	input
4	(reserved)	-
5	RTS	output
6	GND	-
7	(reserved)	-
8	(reserved)	-
9	(reserved)	-
10	(reserved)	-

EAS		
Pin	Description	Direction
1	(-)	-
2	(+)	-

POWER		
Pin	Description	Direction
1	+12V	input
2	GND	

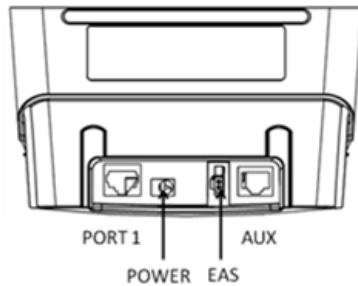





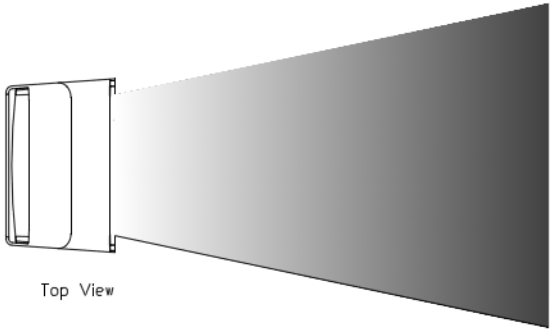

	PORT 1	Power(+12V)	EAS	AUX
Connector Type	RJ48 10 Pin No Key	DC Jack Type:PJ051A	2 Pin Hirose:DF1B	RJ48 10 Pin Left--Keyed
Function	RS-232 USB KBW	Power	EAS	AUX

B TECHNICAL SPECIFICATIONS

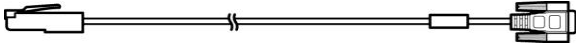
Electrical	
Power Supply Voltage	100 – 240 V ac 50/60 Hz (adapter)
DC Input to Scanner	+12V DC
Power Consumption	6W
Operating Current	500mA
Standby Current	400mA
Interfaces	RS-232 / USB / Powered-USB / Keyboard Wedge
Optical	
Light Source	Visible laser diode (650 nm)
Depth of Field	Up to 250 mm @EAN 0.33mm/13mil , PCS90%
Scan Pattern	5 directions scan field, 30 lines scan pattern
Scan Rate	3,000 scans per second
 <p>Top View</p> <p>Barcode minimum element</p> <p>— — Code39 0.127mm (30~60)mm</p> <p>— — Code39 0.15mm (30~100)mm</p> <p>— — Code39 0.26mm (30~200)mm— </p> <p>— — EAN 0.26mm (20~200)mm— </p> <p>PCS 90% — — EAN 0.33mm (20~250)mm— </p> <p>0 20 40 60 80 100 120 140 160 180 200 220 240 250</p>	
Decoding	
Barcode Types	Automatically discriminates major standard 1D bar codes, include GS1 databar family, Omnidirectional, Omnidirectional Stacked, Expanded, Expanded Stacked, Truncated and Limited.

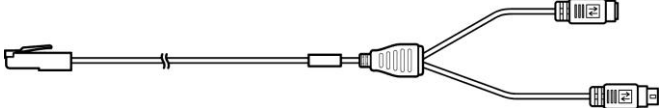
Physical	
Weight	720g / 25.416oz
Dimensions	H x W x L : 152.07 x 152.02 x 90.22 mm : 5.99 x 5.98 x 3.55 inch
Environmental	
Light Level	Max 7,000 Lux
Operating Temperature	0° C ~ 40° C
Storage Temperature	-20° C ~ 70° C / -4°F~ 158°F
Humidity	5% ~ 95% RH (non-condensing)
Sealing Protection	IP42
Safety	
Laser Safety	IEC 825-1 Class I, U.S. CDRH: 21CFR1040 Class II a
Electrical Safety	EN 60950 second edition
EM Compatibility	
Radio and TV Interference	EN 55024/22, FCC Part 15 class B, CNS 13438

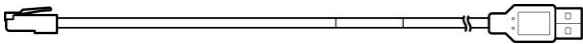
C INTERFACE TYPE

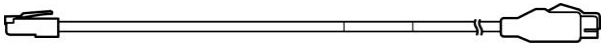
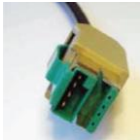
Interface Cable	Connector Type
RS232 (Product Number: 0114-S806121)	Sub-D 9-pin
	
Keyboard Wedge (Product Number: 0114-S805121)	Standard PS2
	
USB (Product Number: 0114-S802121)	USB connector
	
Powered USB (Product Number: 0114-S801121)	Powered USB connector
	

D MAINTAINING THE SCANNER

This scanner requires little maintenance. Only occasional cleaning of the scanner window is necessary to remove dirt and fingerprints. Cleaning can be performed during operation with a non-abrasive glass spray cleaner and a soft lint-free cloth.

E CONTROLLING THE SCANNER FROM THE POS

This scanner can be controlled from the POS via the RS232C interface. Control is achieved by transmitting the following single byte commands to the scanner. In the default setting the following commands are available (more details upon request):

ASCII Code	Function	Byte Also Called:
05 Hex	power-up re-initialization	ENQ or <Ctrl-E>
0E Hex	enable (cancel disable)	Shift Out or <Ctrl-N>
0F Hex	disable	Shift In or <Ctrl-O>
12 Hex	sleep	DC2 or <Ctrl-R>
14 Hex	wake (cancel sleep)	DC4 or <Ctrl-T>

When the scanner is disabled (indicated by the blinking Blue LED), the motor of the scanner will stay on until the scanner goes into sleep mode.

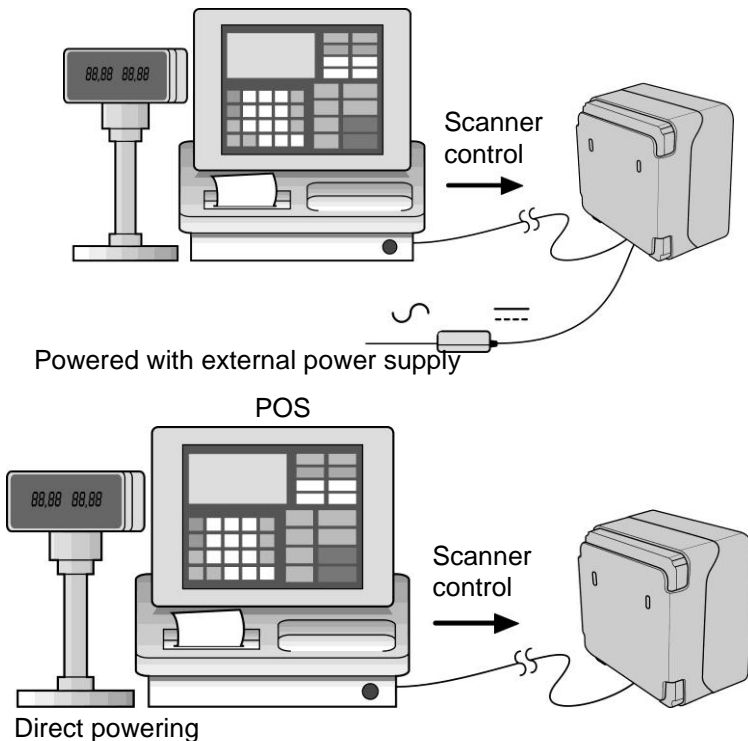

F TROUBLESHOOTING

This section contains information on solving problems you may encounter when using the scanner. If troubles occur, take a moment to read the information in this section. However, before referring to the diagnostic tips makes sure that the scanner is installed as described in Chapter 2 and that all cables are properly connected.

Problems	Diagnostic Tips
The scanner is on but a barcode cannot be read. The LED is blue.	<ul style="list-style-type: none"> ▪ The scanner window is dirty. Clean the scanner window as described in the Maintenance section. ▪ The presented barcode type is not enabled. Select the barcode type with the Configuration Guide. ▪ The scanner is disabled by the host. ▪ The barcode type you presented to the scanner is not supported by the scanner.
The scanner is on, but the motor is not rotating. A barcode cannot be read. The LED is intermittently flashing orange.	<ul style="list-style-type: none"> ▪ The scanner is in sleep mode. Press the Sleep/Wake Button to reactivate the scanner or use the wake protocol.
The LED is alternating blue/orange.	<ul style="list-style-type: none"> ▪ Mirror motor is defective and must be replaced (Authorized personnel only).
The LED is alternating blue/orange and beeps are heard.	<ul style="list-style-type: none"> ▪ Possible failure of the detecting protective circuit. Immediately disconnect the scanner from its power source. Contact your supplier.
The scanner does not accept more than two or three barcodes.	<ul style="list-style-type: none"> ▪ There is no proper handshaking with the host system. Switch the host system on and check connection and communication settings.
The LED is blinking blue/orange.	<ul style="list-style-type: none"> ▪ The ambient temperature is too high. Make sure the scanner has enough air ventilation and is not placed in direct sunlight.

Problems	Diagnostic Tips
The LED remains blue.	<ul style="list-style-type: none"> ▪ The scanner is continuously reading a barcode. Remove all barcode labels from the scan volume of the scanner and try again. ▪ The scanner cannot send the data to the host system. There is no proper handshaking between the scanner and the host. Scanner buffer is full. Make sure that all cables are connected and your host system is ready to receive data.
A barcode is read by the scanner but not accepted by the host system.	<ul style="list-style-type: none"> ▪ The communication cable is not connected to the serial port of your host system. Refer to the manual of your host system to locate the serial port. ▪ The communication settings of the host and scanner do not match. Ensure that the setting values for both devices are the same. For proper adjustment values see the Configuration Guide. ▪ The communication cable does not suit your host system. Contact your supplier for the correct communication cable. ▪ The data format is not supported by the software running on the host system.

Problems	Diagnostic Tips
<p>USB is not working.</p>	<ul style="list-style-type: none"> ▪ Unless you use USB plus power, you need a separate power connection to the scanner like the external power supply. ▪ Restart the scanner by temporarily disconnecting the power. This may help the POS system to detect the scanner. The very first time the PC might install some general drivers, possibly from your computer setup CD. ▪ In case of KB emulation you can select various 'keyboard languages' or the universal 'Alt-input-method'. ▪ In a windows environment verify with the device manager that a HID (Human Interface Device) is installed for the scanner. ▪ Ensure that both the scanner and POS-system/Computer expect the same USB protocol (KB emulation, RS-232 emulation or IBM POS protocol). See Configuration Guide for setup codes and reset (re-power) the scanner after making any changes.

Due to Champtek's / Scantech ID's continuing product improvement programs, specifications and features are subject to change without notice.

